

FEATURES

OPTICS

frosted acrylic lens
frosted asymmetric collimator

INSTALLATION

for best results cove framing system should be installed by carpenter, finished with sheet rock, tape and skim coat before light fixture installation. LED fixtures snap on to mounting posts in cove framing.
framing must be installed in compliance with MRI construction procedures
power supply must be located outside of faraday cage

MATERIALS

aluminum flexible cove framing system, flexible continuous face plate for skim coat, extruded aluminum LED fixture comes standard with 2' feed
comprised entirely of non-ferrous materials

CERTIFICATIONS

cULus Listed, JA8 and damp listings available
Made and designed in the USA
EMI: Compliant with FCC CFR Title 47 Part 15 Class B at 120 Vac & Class A at 277 Va

OPTIONS

jumper cable 6 foot
adjustable mounting clip (ASY only)
2000K, 2200K, 2400K available on request
acoustabult 7/8" acoustic coling ceiling
consult factory for modification requests

RECOMMEND GAUGES FOR REMOTE WIRE DISTANCE:

	MAX. REMOTE DISTANCE
18 AWG	30 FT
16 AWG	50 FT
14 AWG	75 FT
12 AWG	100FT

LUMINAIRES

FWD - FOWARD THROW

DISTANCE FROM CEILING 6"+

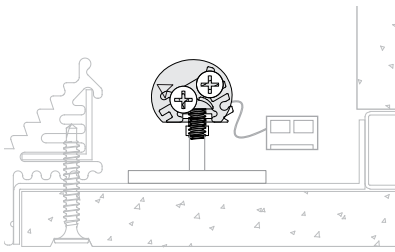

BAR - SYMMETRIC

DISTANCE FROM CEILING 12"+

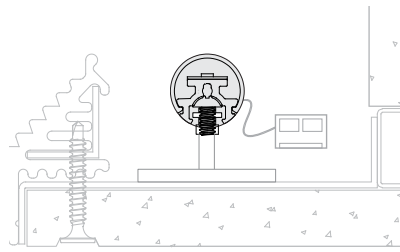

ASY - ASYMMETRIC

DISTANCE FROM CEILING 4" -12"

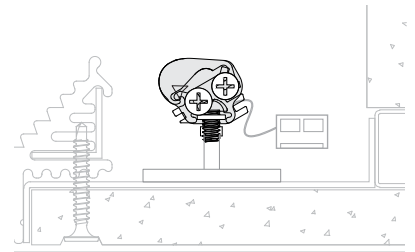

PHOTOMETRICS

*ALL PHOTOMETRIC DATA SHOWN FOR 10W/FT 4' FIXTURE @ 3000K

FWD

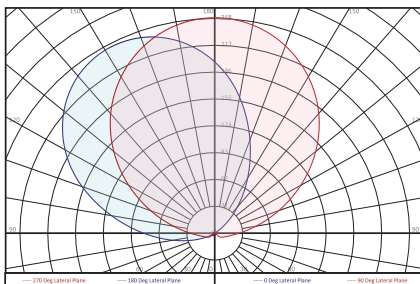

POWER
38 watts

LUMENS
4370 lm

BAR

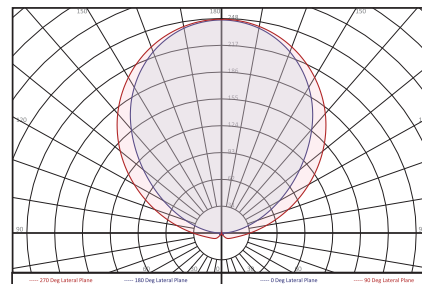

POWER
38 watts

LUMENS
4370 lm

ASY

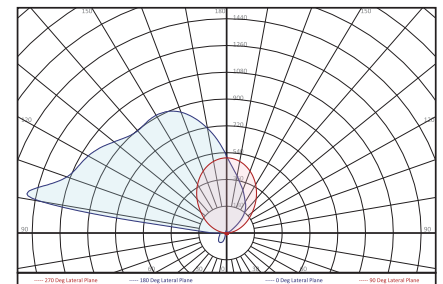

POWER
38 watts

LUMENS
3640 lm

PAT.10,295,132



FREE-FORM GUIDE

CURVE REQUIREMENTS

fixture can be installed in straight runs or in complex curves. framing system is dynamically flexible down to a 6" minimum radius.

*DRAWINGS NOT TO SCALE

GLSKE5
42 IN FLEX FRAMING

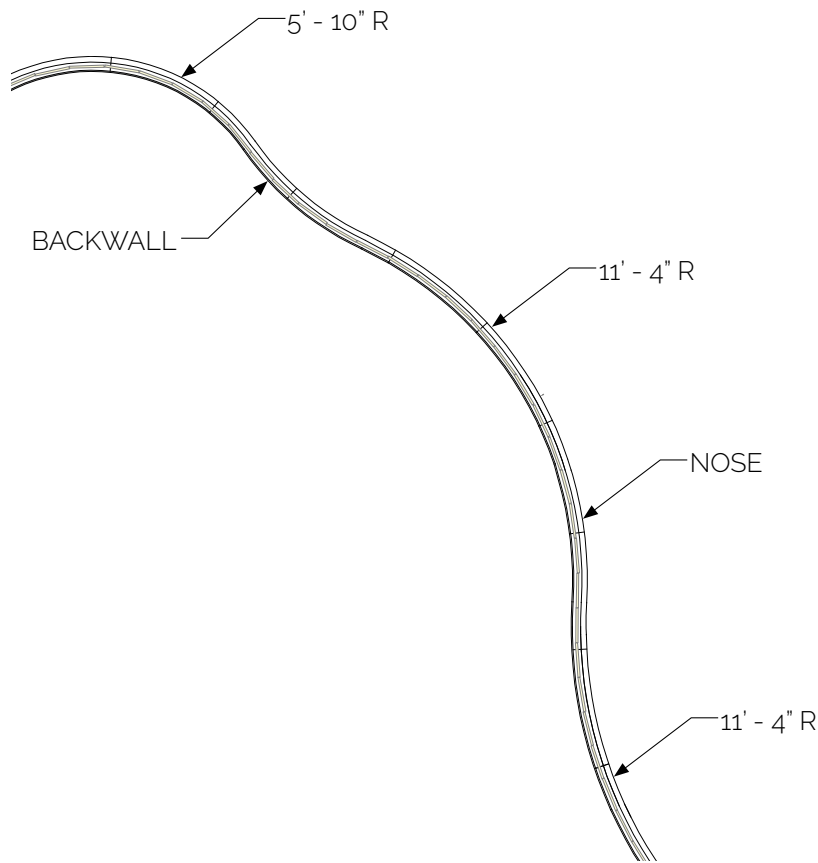

GLSKE5
42 IN FLEX FRAMING

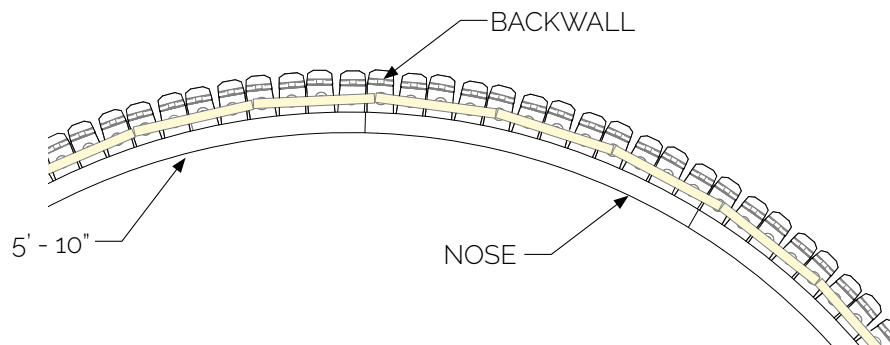

PAT.10,295,132



INSIDE CORNER KIT GUIDE

Curved corners can be made in fixed or flex configurations.
Fixed radius curves have +/- 3° of flex
Flex curved corners have +/- 20° degrees of flex

GLSKE5 IN 6R

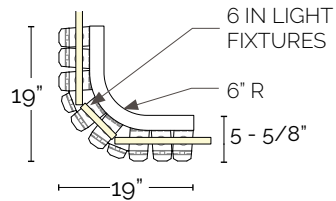

GLSKE5 IN 6R

straight backwall option available

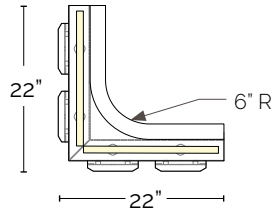

GLSKE5 IN 90D

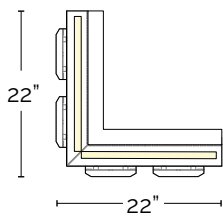

GLSKE5 IN 12R

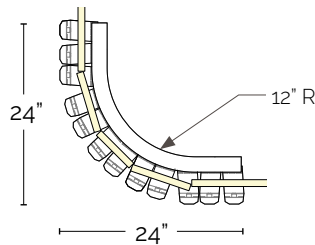

GLSKE5 IN 18R

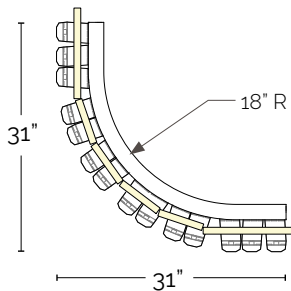

GLSKE5 IN 24R

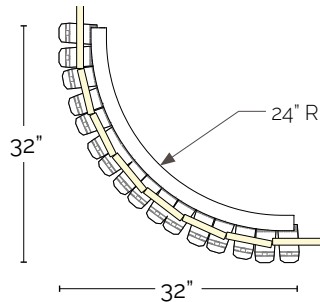

OUTSIDE CORNER KIT GUIDE

Curved corners can be made in fixed or flex configurations.
Fixed radius curves have +/- 3° of flex
Flex curved corners have +/- 20° of flex

GLSKE5 OUT 6R

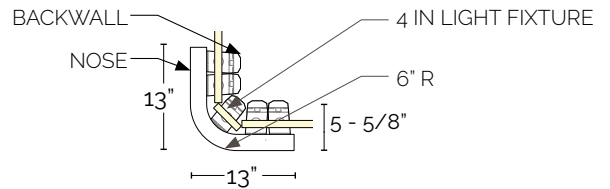

GLSKE5 OUT 90D

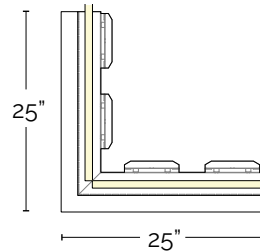

GLSKE5 OUT 12R

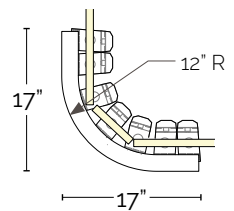

GLSKE5 OUT 18R

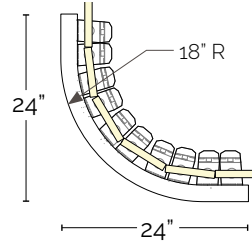

GLSKE5 OUT 24R

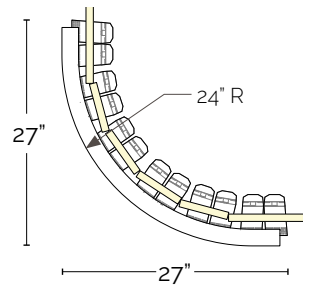

CONSULT FACTORY FOR ADDITIONAL CORNER OPTIONS

OPTIONS

DRIVER BOX
12" X 6" X 12"

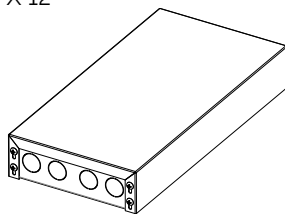

INPUT WHIP

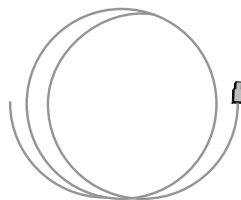

JUMPER CABLE
6FT

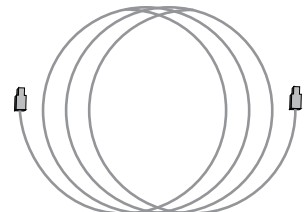

PAT.10,295,132