

PROJECT

FIXTURE TYPE

The GLS Flex Cove is a revolutionary product series that creates a small profile cove capable of being field curved in order to follow complex shapes and designs. The GLS Flex Cove provides a clean and consistent architectural detail that allows for easy installation of indirect linear LED fixtures.

LUMINAIRES

TECHNICAL DRAWING

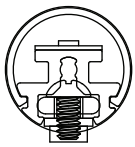

BAR SYMMETRIC

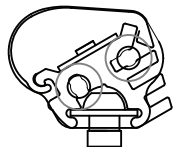

ASYMMETRIC

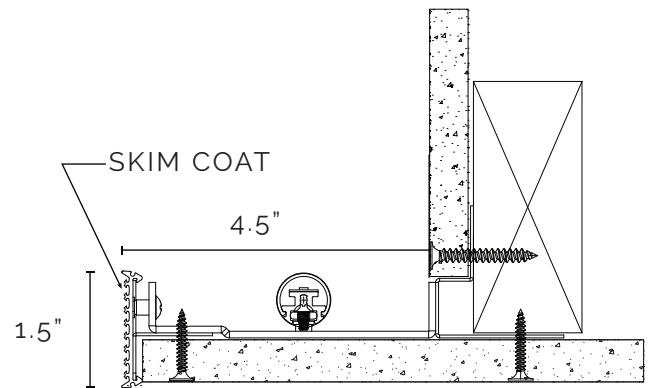

PHOTOMETRICS

BAR SYMMETRIC

power
40.5 watts

lumens
4294 lm

Co Black
C45 Green
C90 Blue

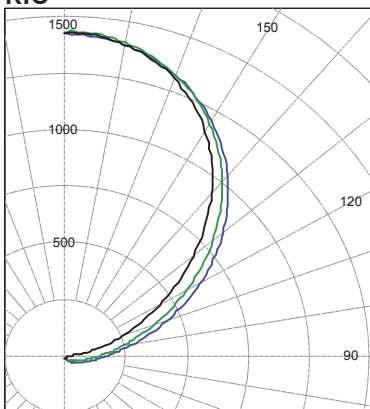

*photometric data shown for 10W/ft.4' fixture @ 3000K

ASYMMETRIC

power
40.5 watts

lumens
4050 lm

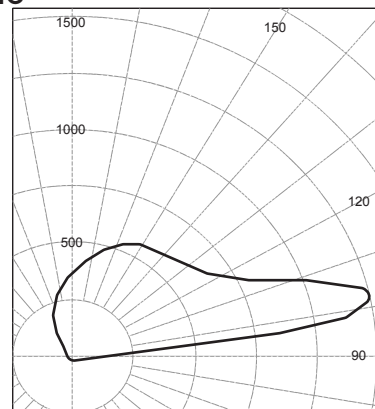

*photometric data shown for 10W/ft.4' fixture @ 3000K

PAT. 10,295,132

FEATURES

output

standard output: 5w per foot 516 lumens per foot
high output: 10w per foot 1057 lumens per foot

optics

frosted acrylic lens

curve requirements

fixture can be installed in straight runs or in complex curves
minimum radius of 4' with standard product
smaller radius can be provided as needed

materials

aluminum flexible cove framing system, flexible continuous face plate for skim coat, extruded aluminum LED fixture

driver

remote 120-277v driver with 0-10V dimming controls

options

90° inside and outside corner kits and soft radius corner kits available

certifications

UL Listed, Made in the USA

ORDERING

FRAMING

GLS-FLEX-4SQ

FRAMING OPTIONS

ICK - inside corner kit
OCK - outside corner kit
ICKR - inside corner kit - round
OCKR - outside corner kit - round
XX' - custom radius*
* for any radius smaller than 4'-0"

SPECIALTY OPTIONS

RGB
RGBW
DIM TO WARM - 2200K-3000K
COLOR TUNING - 2700K-6500K

CONTACT FACTORY FOR CUSTOM WATTAGES

EXAMPLE
GLS-FLEX-4SQ BAR-5-0-10V-30K

LUMINAIRE

BAR - symmetric output
ASY - asymmetric output

OUTPUT

5 - 5w per foot output
10 - 10w per foot output

CONTROL

ND - non dimming
0-10V - 0-10V dimming
H3D - lutron hilume 3D
ECO - lutron ecosystem
OTHER - specify
POE - specify POE controller

COLOR TEMPERATURE

27K - 2700K
30K - 3000K
35K - 3500K
40K - 4000K

PAT. 10,295,132

FEATURES

OUTSIDE CORNER - OCK

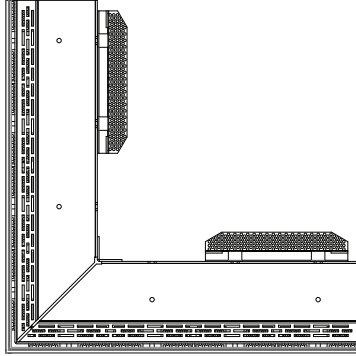

INSIDE CORNER - ICK

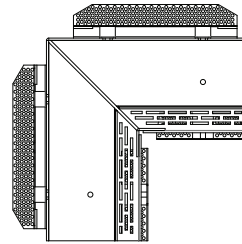

**ROUND OUTSIDE CORNER - OCKR
6" RADIUS**

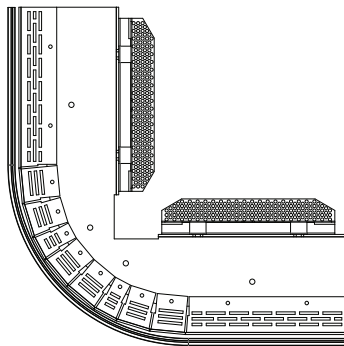

**ROUND INSIDE CORNER - ICKR
6" RADIUS**

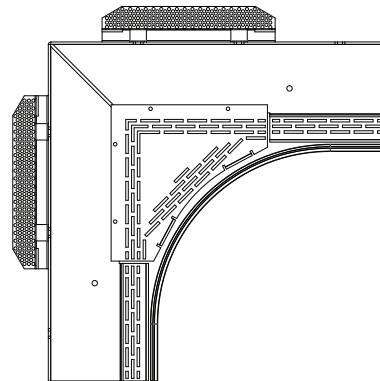

PLAN VIEW

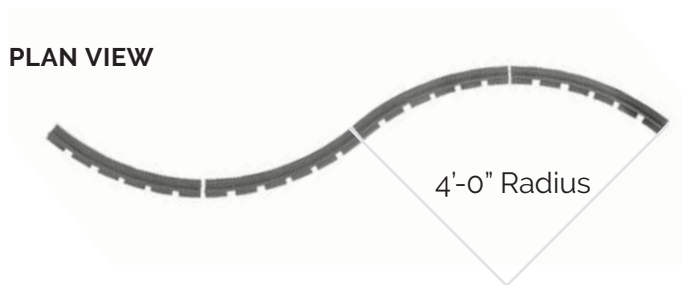

**DRIVER BOX
12"x6"x2"**

